



STARFLYER

STARFLYER AIRBUS A320 : PATTERN



Canon® is a registered trademark of Canon Inc.

© Canon Inc. © P. Model K. Kiyonaga



<http://www.canon.com/c-park/en/>



Completed Model (Total length)	About 520mm (Scale - About 1:72)
(Total width)	About 468mm
Pattern	19 pages (No.of Parts: 296)
Assembly Instruction	20 pages

STARFLYER AIRBUS A320

This model is based on the STARFLYER AIRBUS A320, a passenger aircraft manufactured by Airbus and operated by Star Flyer Inc., and covers the route between Tokyo's Haneda Airport and Kitakyushu.

This beautifully refined black aircraft was designed with the image of "21st century chic". Seat numbers have been reduced to 144 from the standard 170, allowing 12cm extra legroom for each seat. All seats are covered in leather, and equipped with power outlets for laptop computers, and plasma screen personal TV sets.

The AIRBUS A320 features an overall length of 37.57m and is 11.76m high, with a wingspan of 34.10m.

With a maximum take-off weight of 77 tons and an economical cruising speed of 840 km/h, it can cover distances of up to 5,500 km.

This model was designed for Papercraft and may differ from the original in some respects.

*Build the model by carefully reading the Assembly Instructions, in the parts sheet page order.



STARFLYER

STARFLYER AIRBUS A320 : PATTERN



Canon® is a registered trademark of Canon Inc.
© Canon Inc. © P. Model K. Kiyonaga

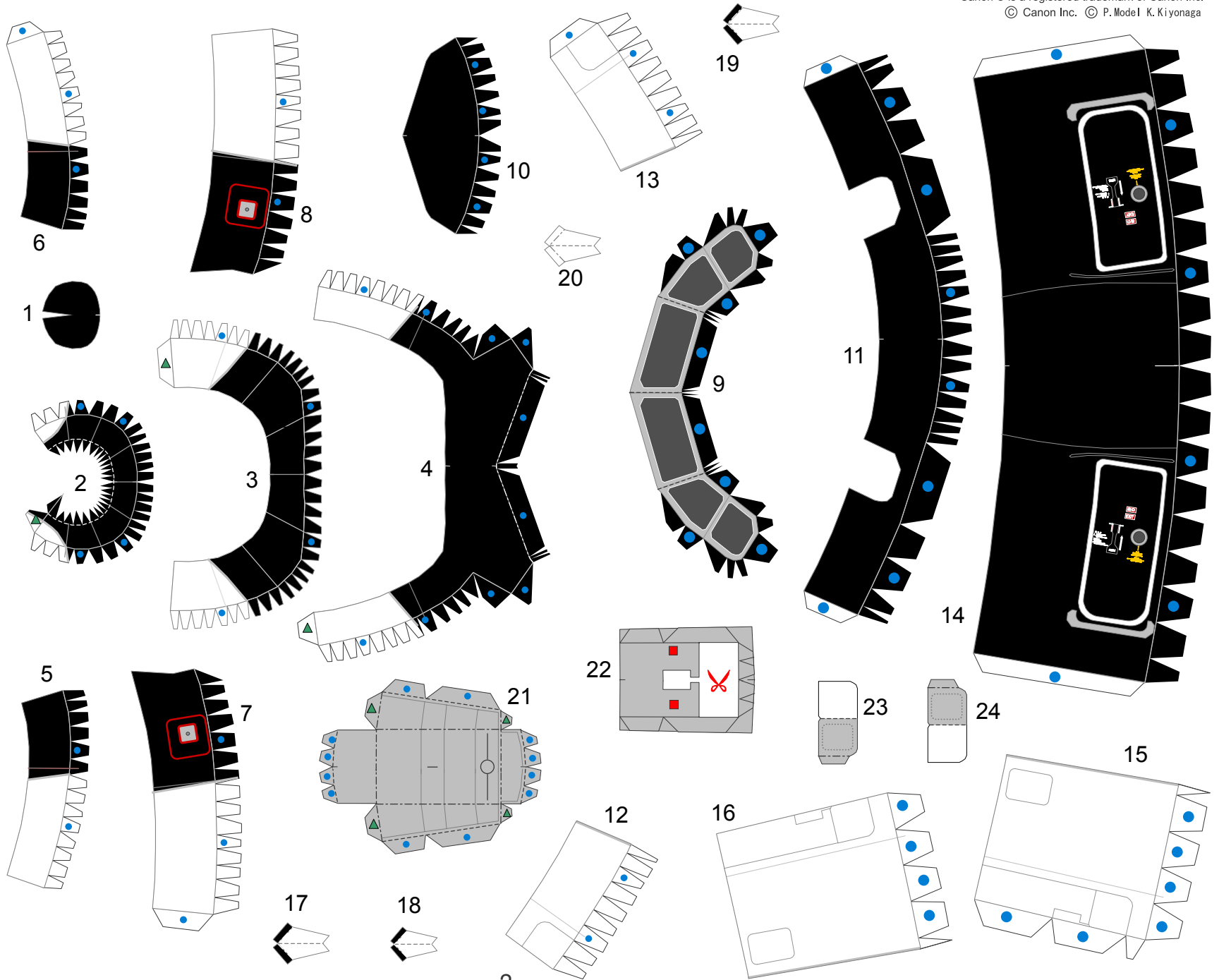



STARFLYER

STARFLYER AIRBUS A320 : PATTERN



Canon® is a registered trademark of Canon Inc.
© Canon Inc. © P. Model K. Kiyonaga

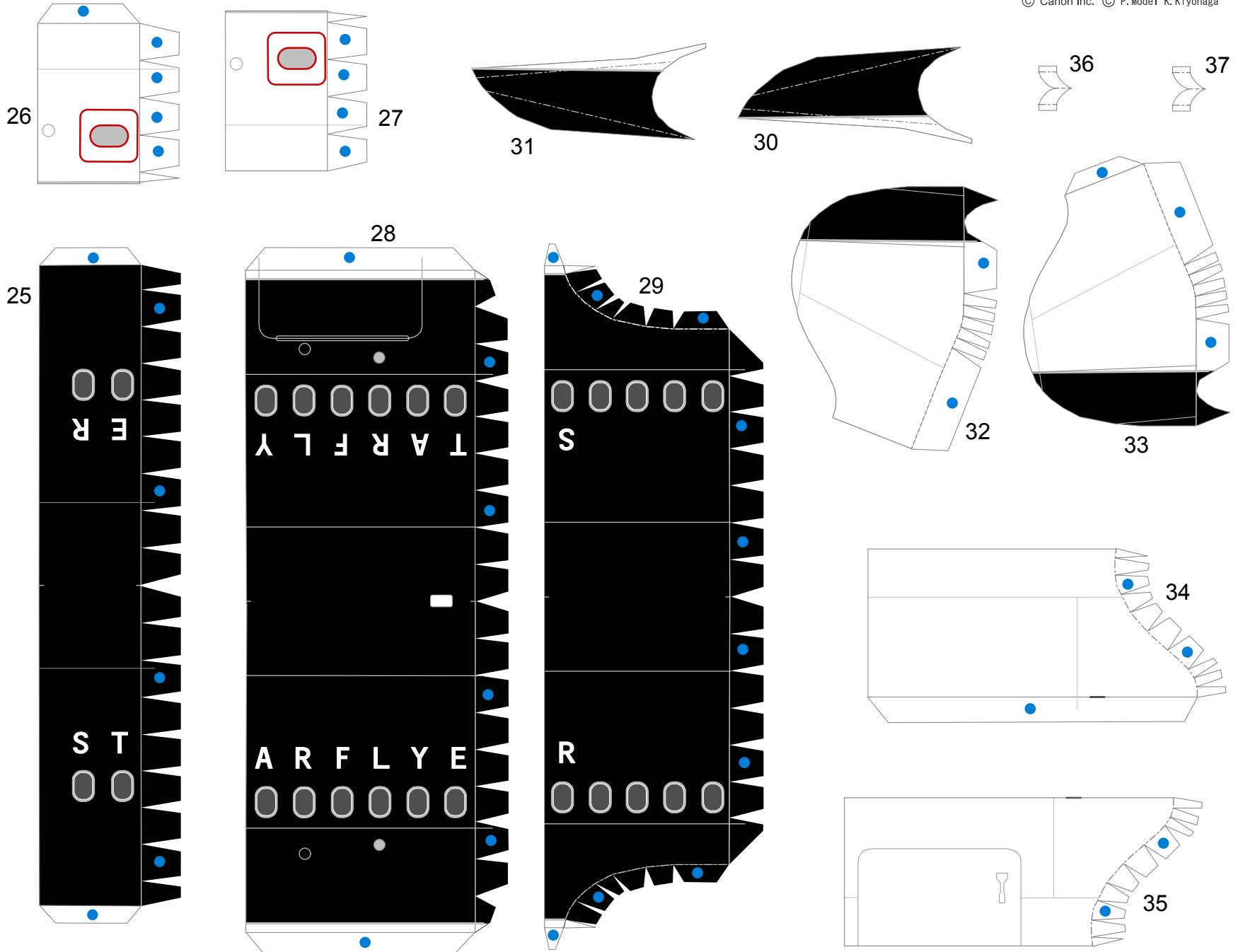



STARFLYER

STARFLYER AIRBUS A320 : PATTERN



Canon® is a registered trademark of Canon Inc.
© Canon Inc. © P. Model K. Kiyonaga

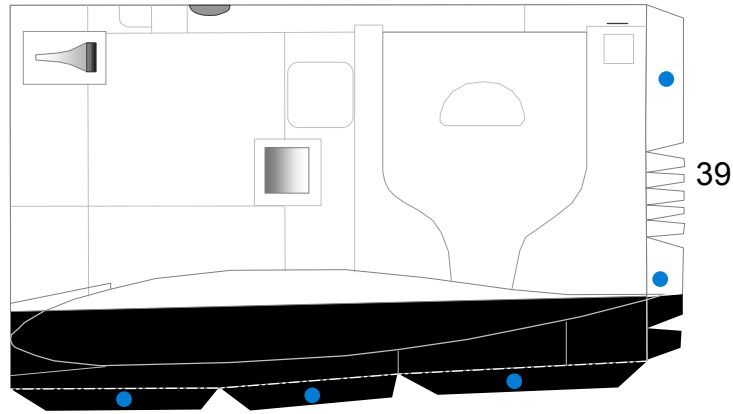

39



45

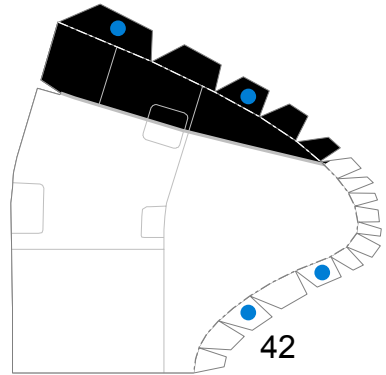

42

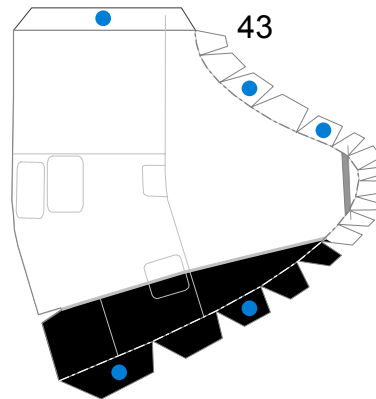

43

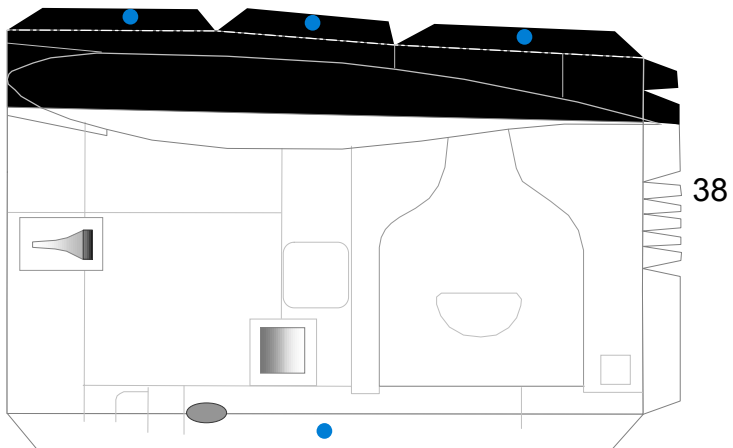

38

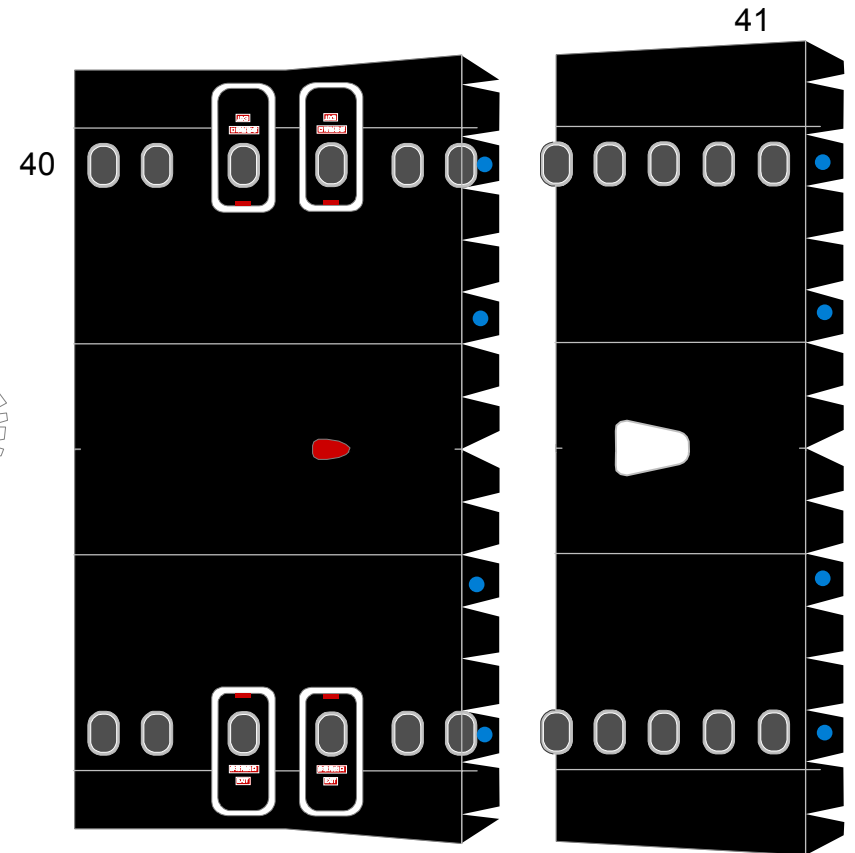

40

41



44



STARFLYER

STARFLYER AIRBUS A320 : PATTERN



Canon® is a registered trademark of Canon Inc.
© Canon Inc. © P. Model K. Kiyonaga

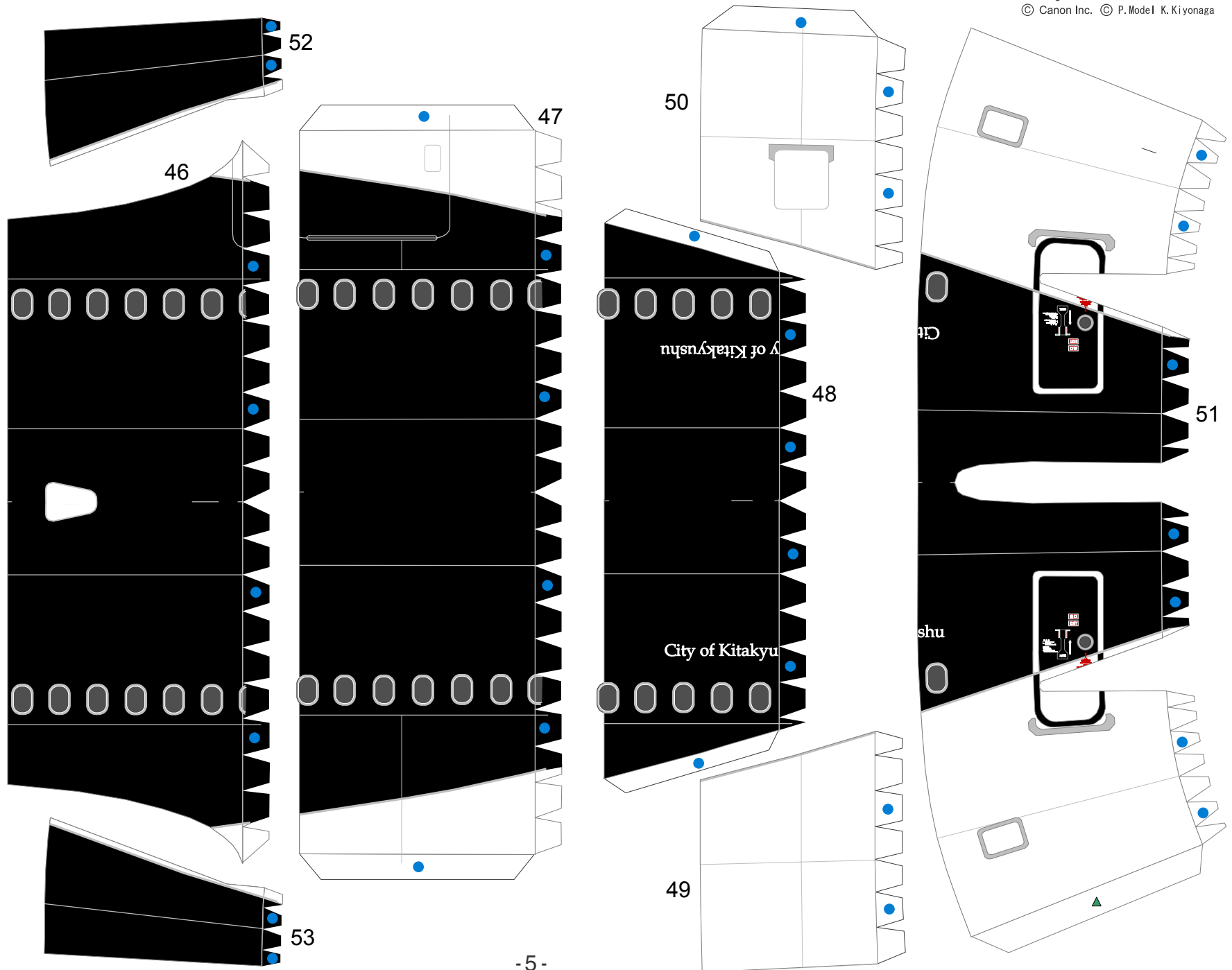



STARFLYER

STARFLYER AIRBUS A320 : PATTERN



Canon® is a registered trademark of Canon Inc.
© Canon Inc. © P. Model K. Kiyonaga

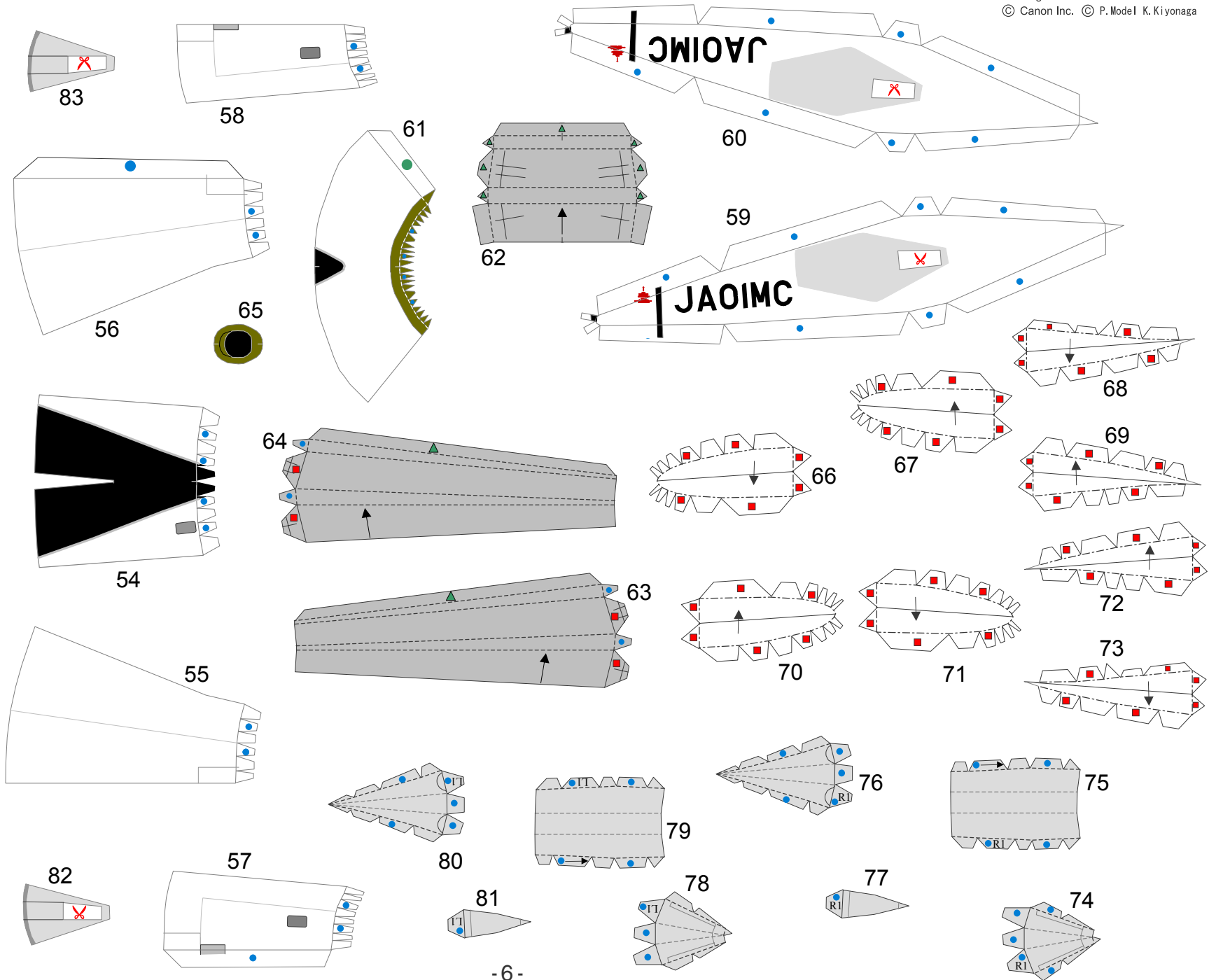



STARFLYER

STARFLYER AIRBUS A320 : PATTERN



Canon® is a registered trademark of Canon Inc.
© Canon Inc. © P. Model K. Kiyonaga

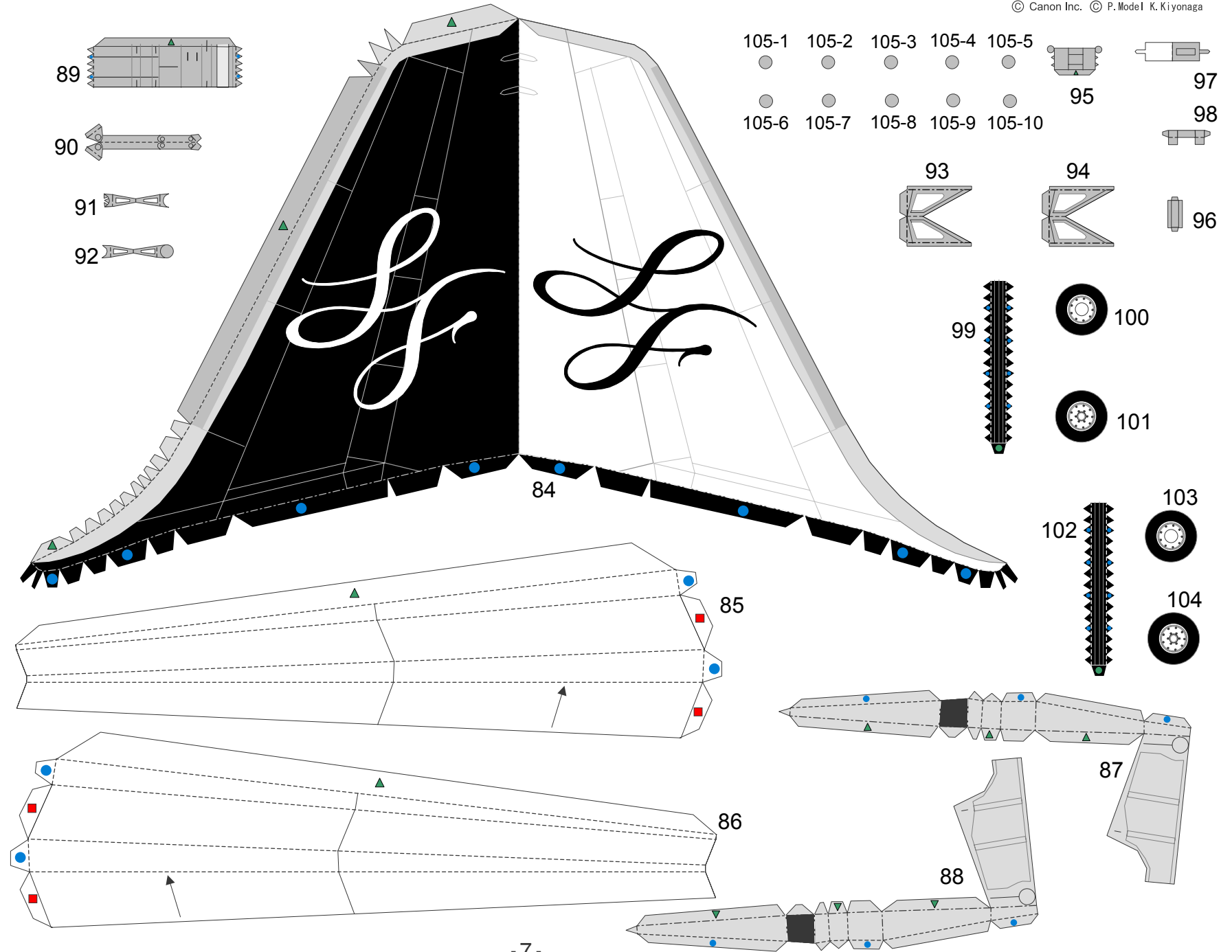



STARFLYER

STARFLYER AIRBUS A320 : PATTERN



Canon® is a registered trademark of Canon Inc.
© Canon Inc. © P. Model K. Kiyonaga

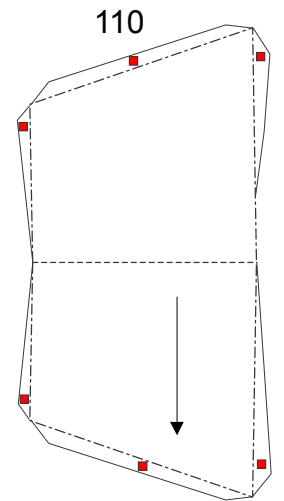
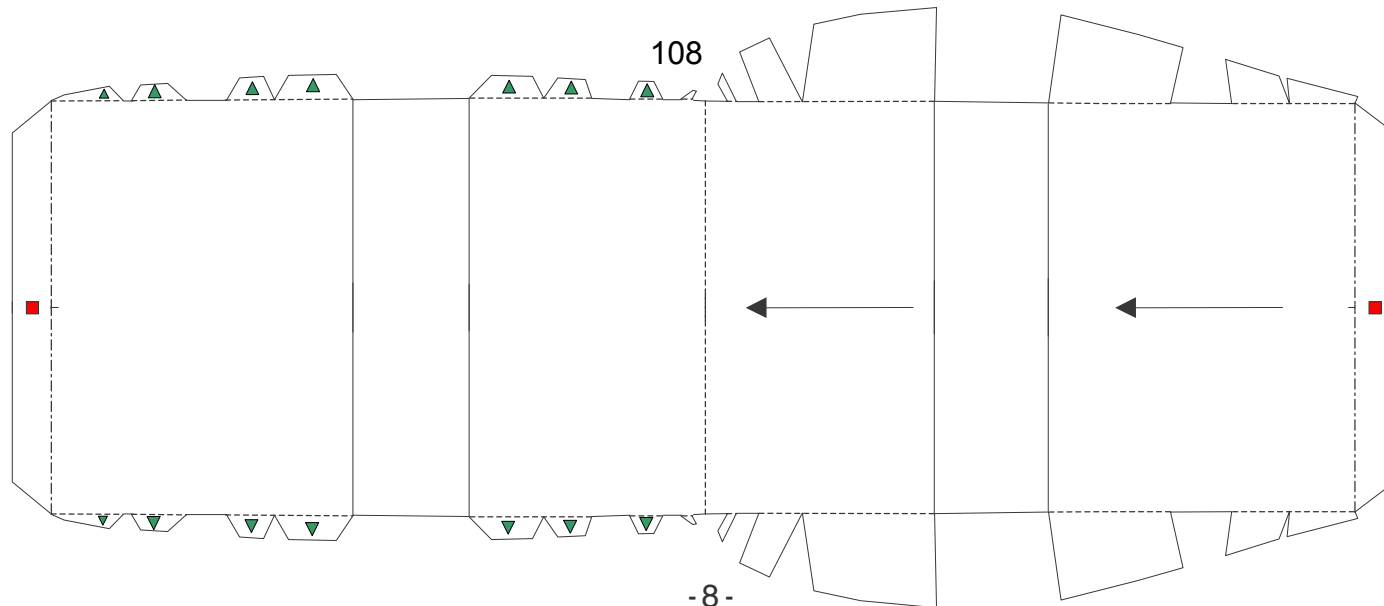
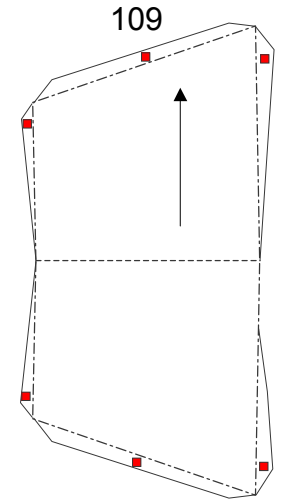
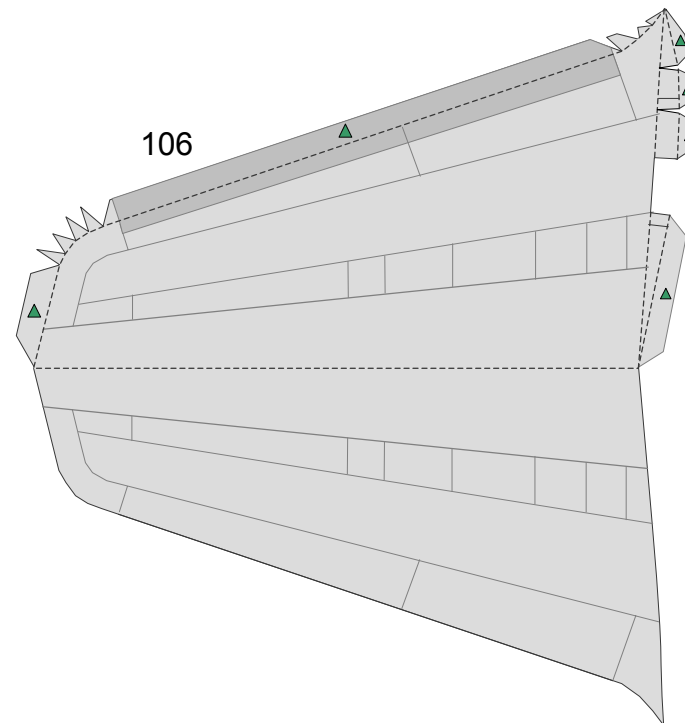
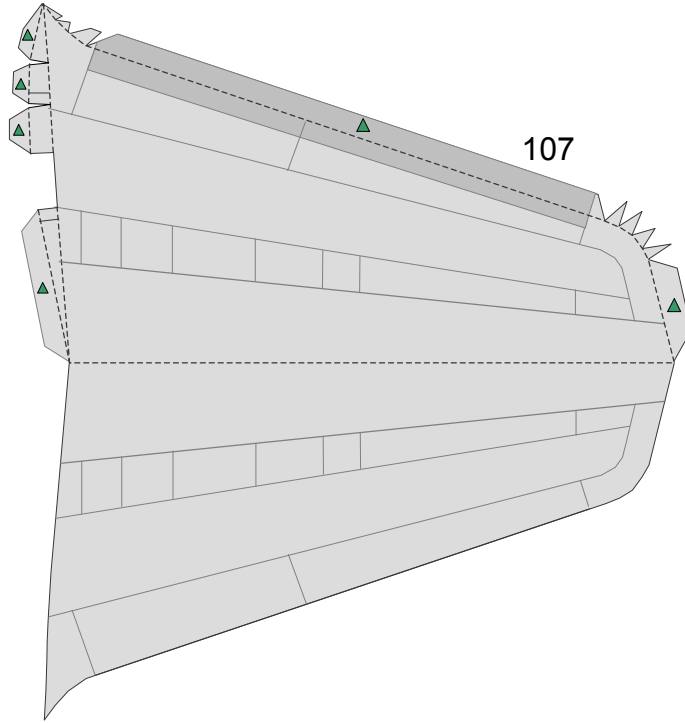



STARFLYER

STARFLYER AIRBUS A320 : PATTERN



Canon® is a registered trademark of Canon Inc.
© Canon Inc. © P. Model K. Kiyonaga

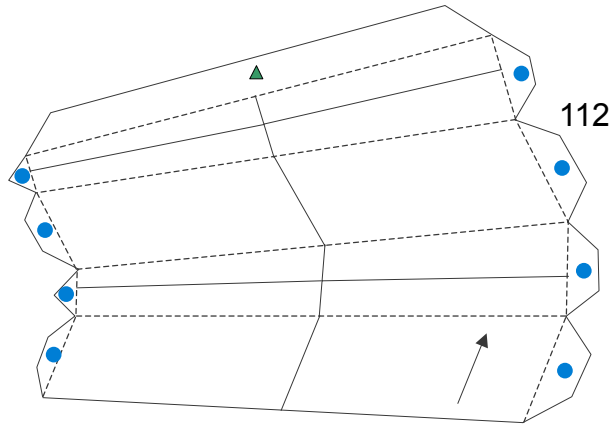

112

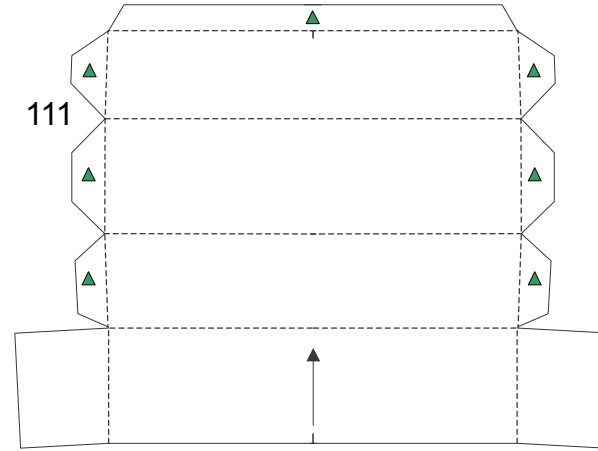

111

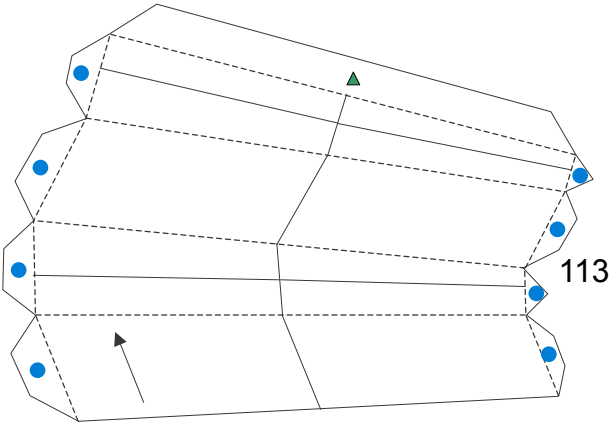

113

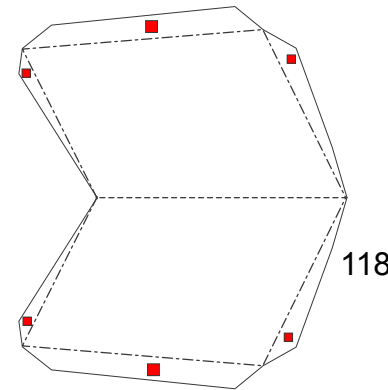

118

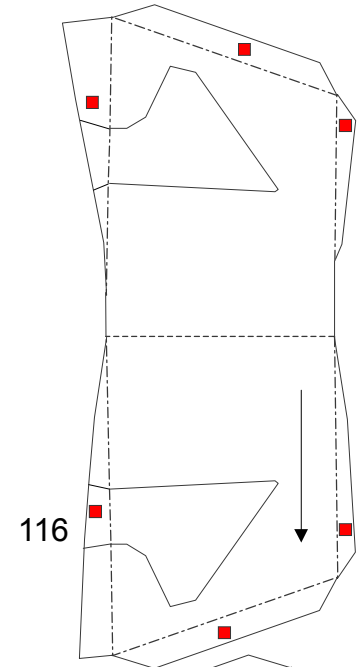

116

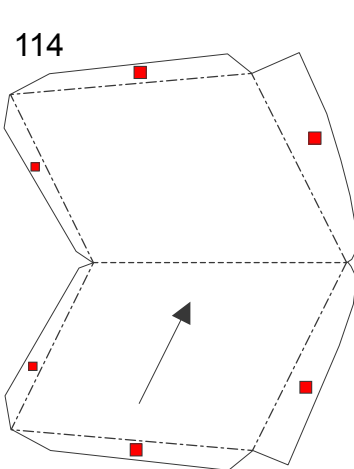

114

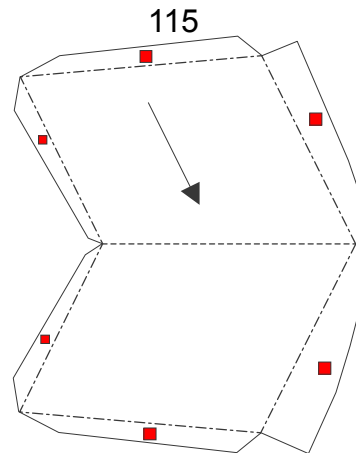

115

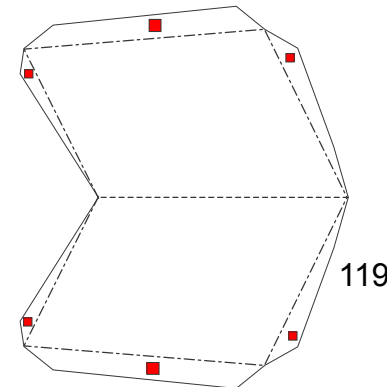

119

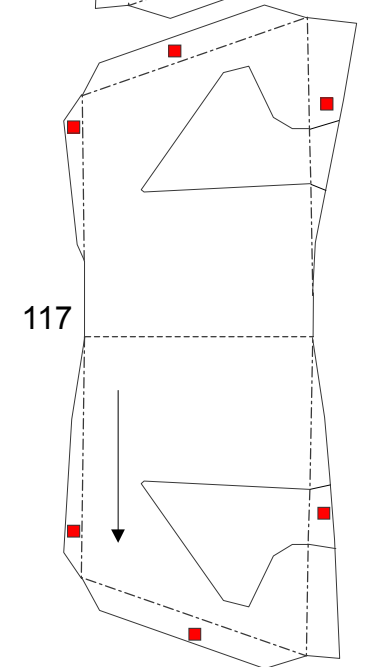

117



STARFLYER

STARFLYER AIRBUS A320 : PATTERN



Canon® is a registered trademark of Canon Inc.
© Canon Inc. © P. Model K. Kiyonaga

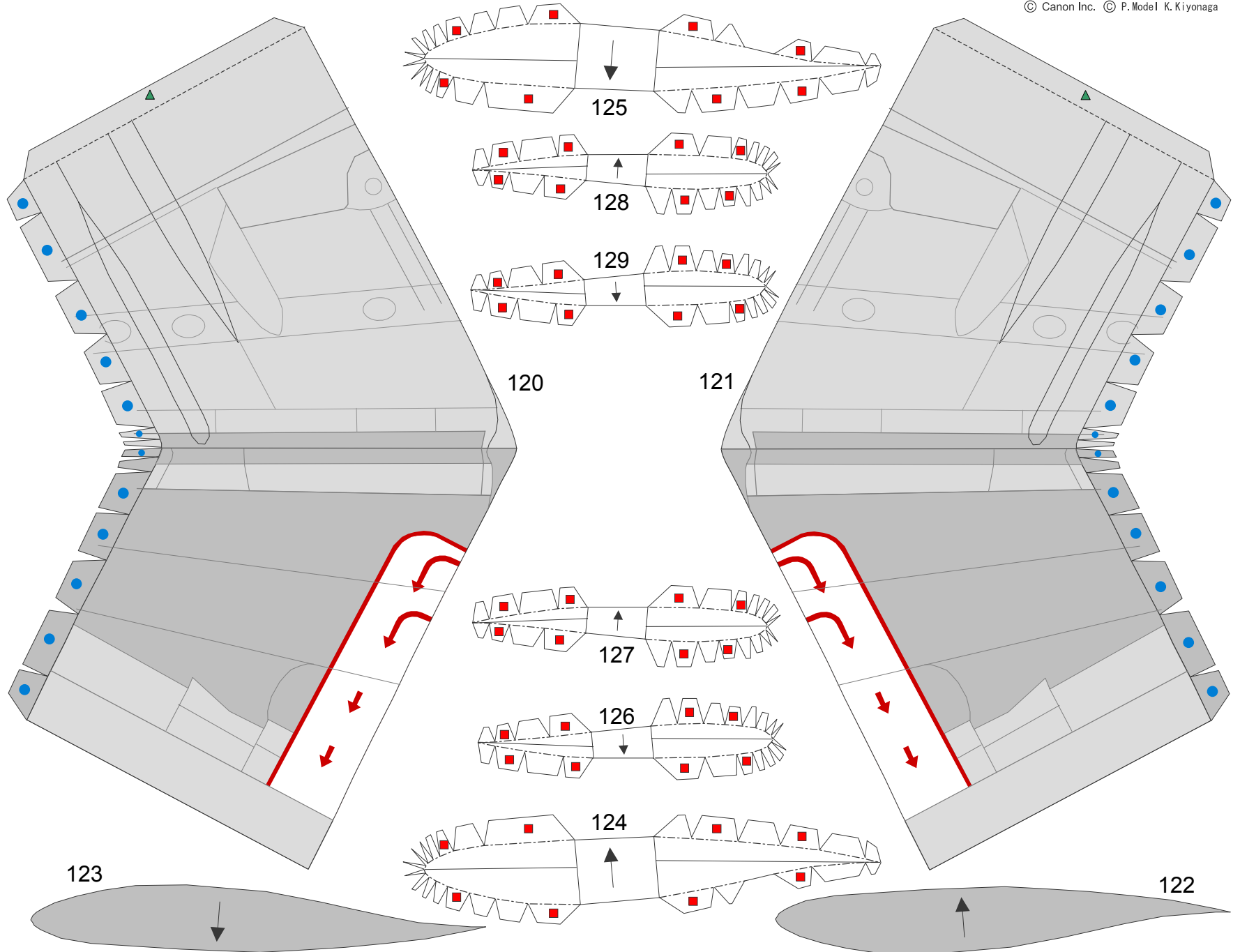



STARFLYER

STARFLYER AIRBUS A320 : PATTERN



Canon® is a registered trademark of Canon Inc.
© Canon Inc. © P. Model K. Kiyonaga

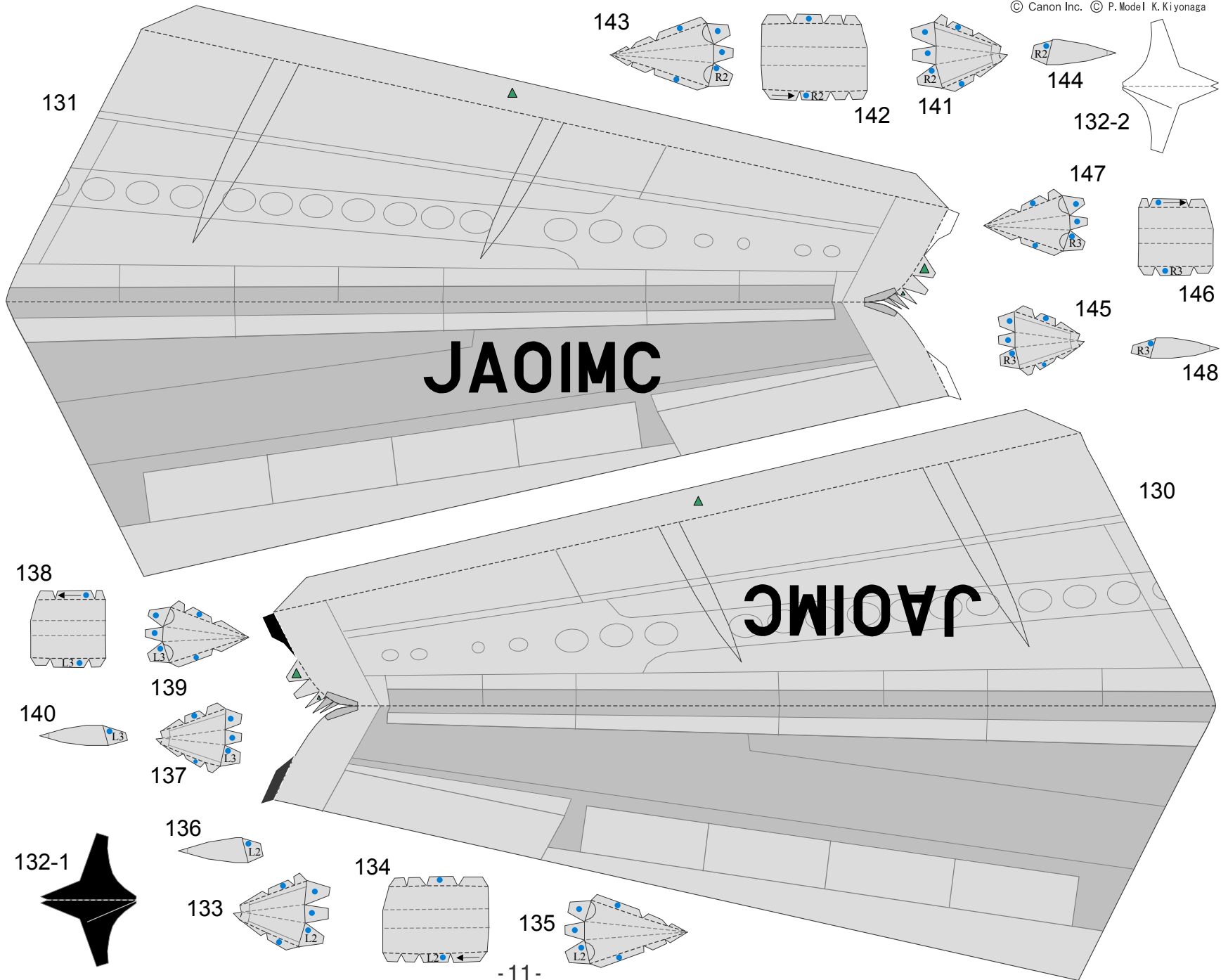



STARFLYER

STARFLYER AIRBUS A320 : PATTERN



Canon® is a registered trademark of Canon Inc.
© Canon Inc. © P. Model K. Kiyonaga

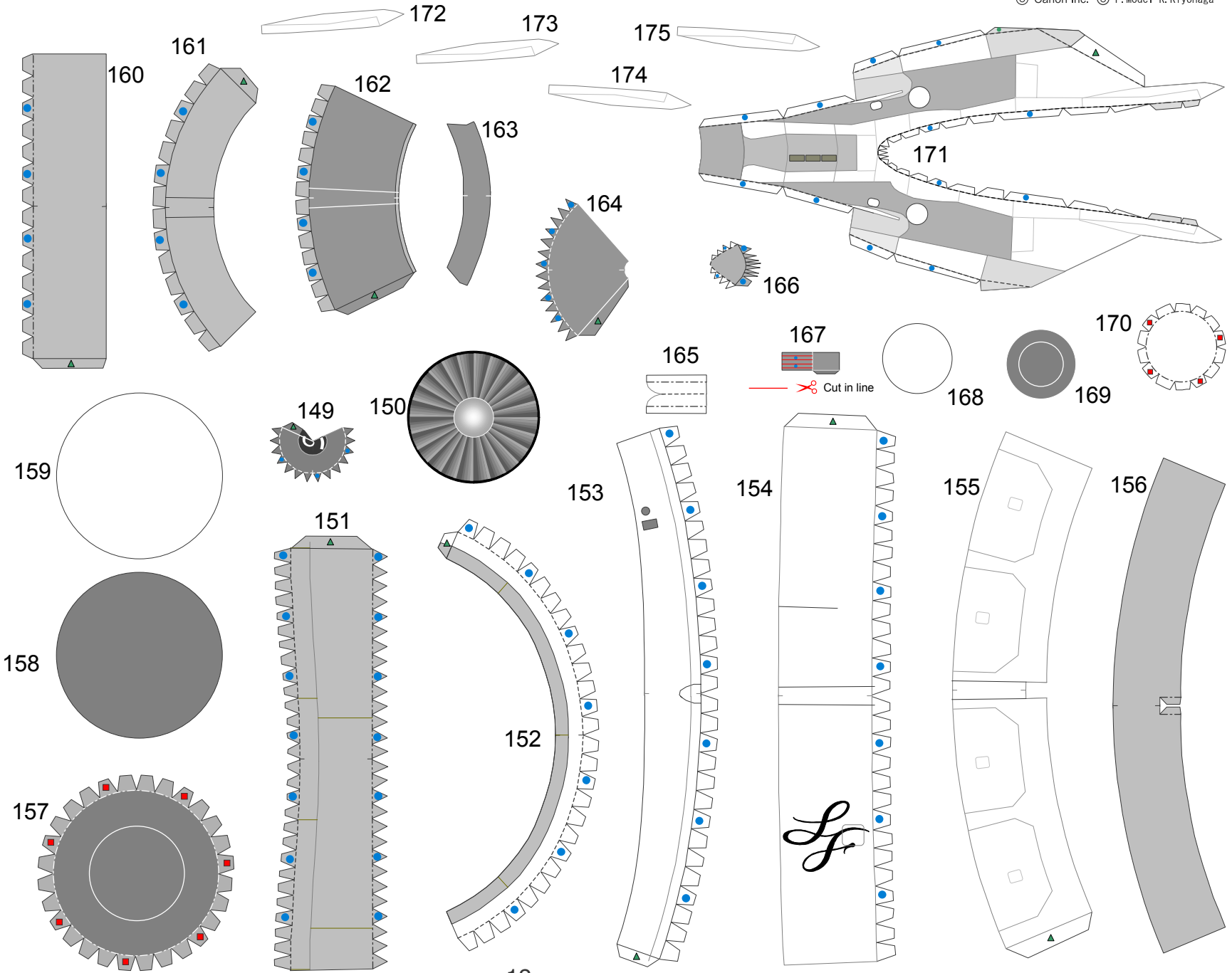



STARFLYER

STARFLYER AIRBUS A320 : PATTERN



Canon® is a registered trademark of Canon Inc.
© Canon Inc. © P. Model K. Kiyonaga

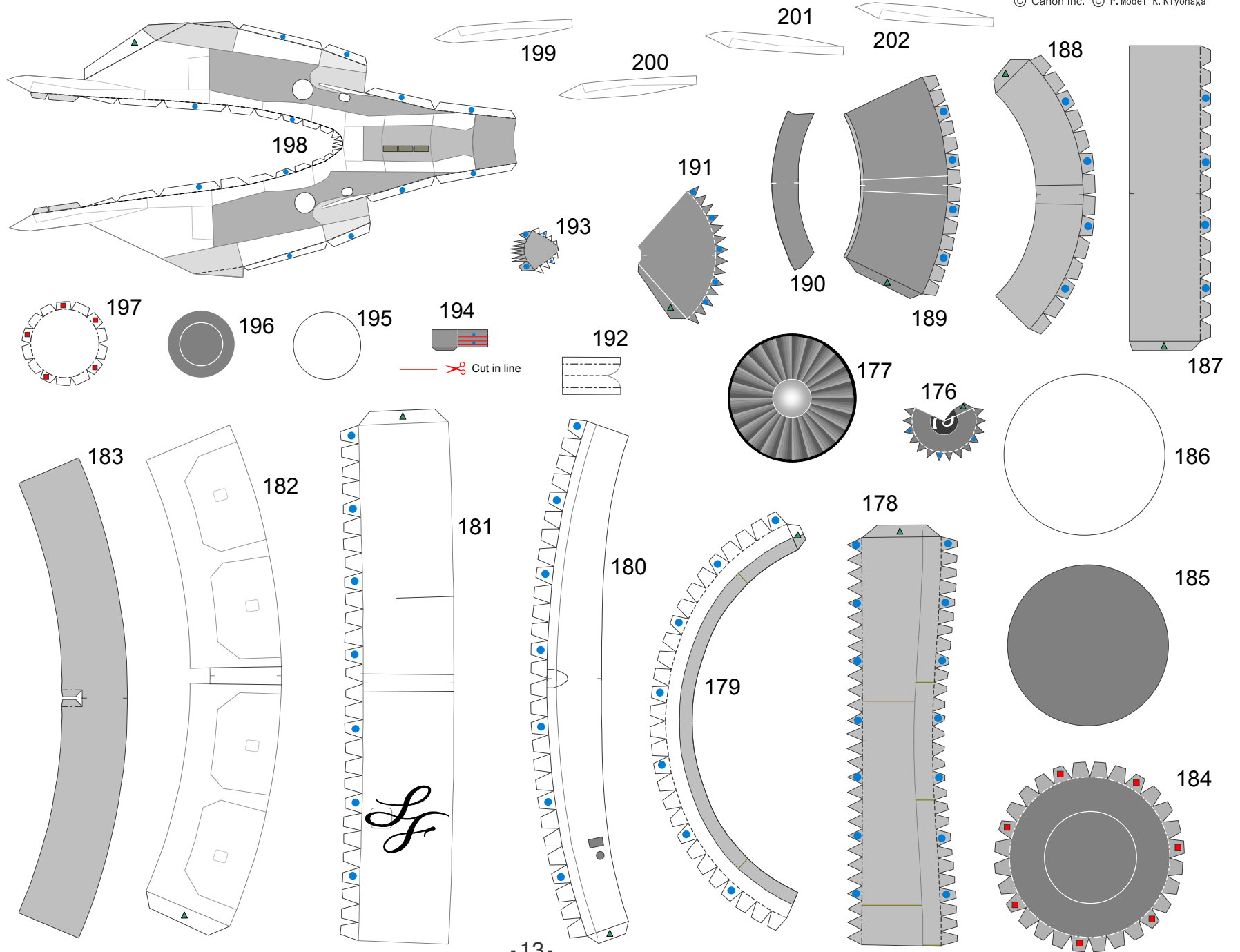



STARFLYER

STARFLYER AIRBUS A320 : PATTERN



Canon® is a registered trademark of Canon Inc.
© Canon Inc. © P. Model K. Kiyonaga

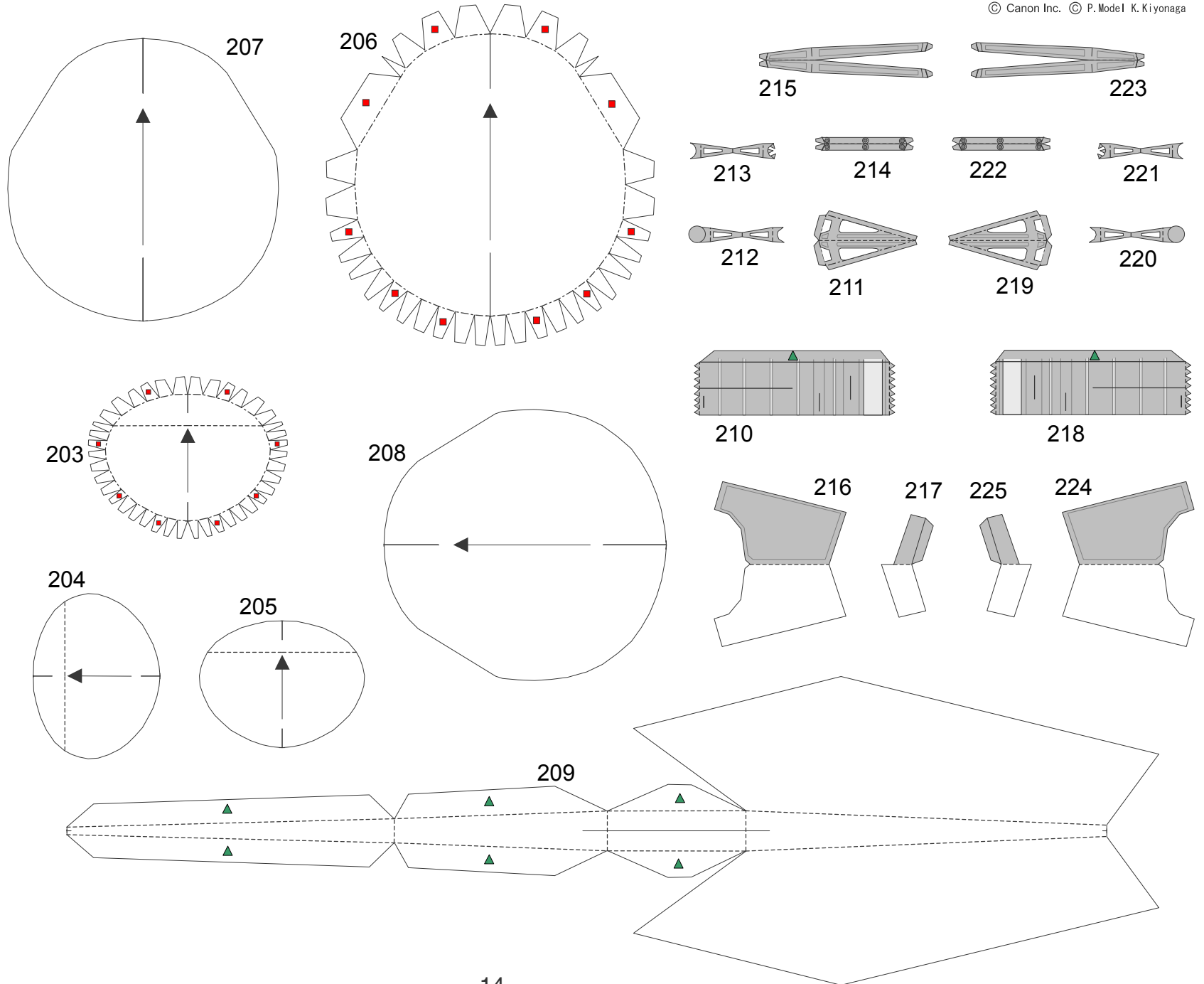



STARFLYER

STARFLYER AIRBUS A320 : PATTERN



Canon® is a registered trademark of Canon Inc.
© Canon Inc. © P. Model K. Kiyonaga

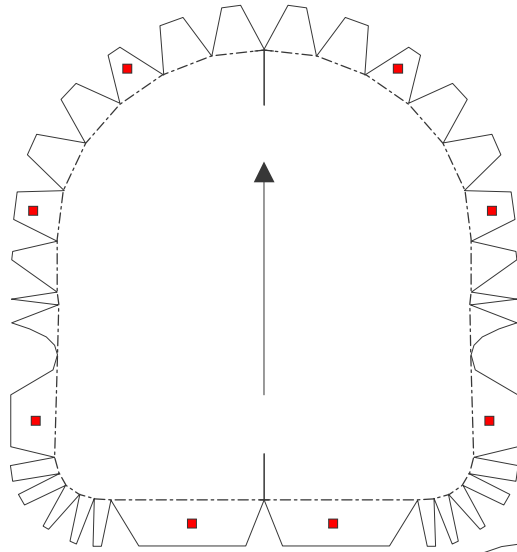

228

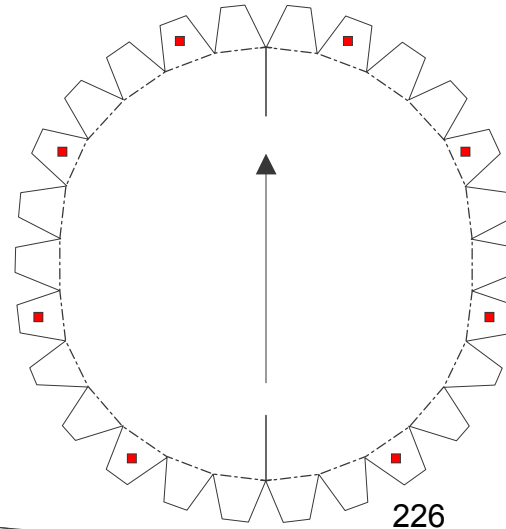

226

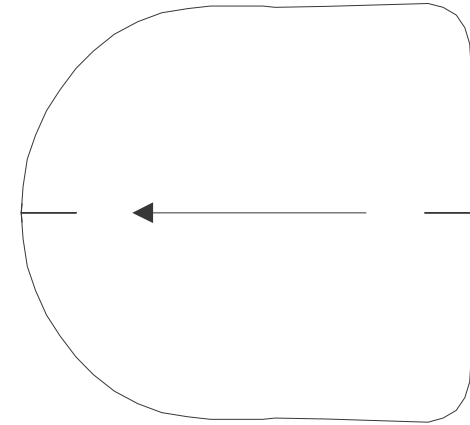

230

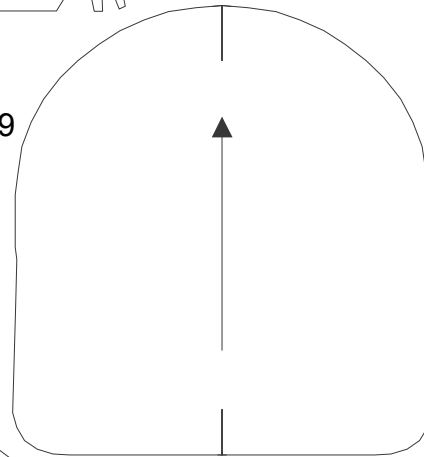

229

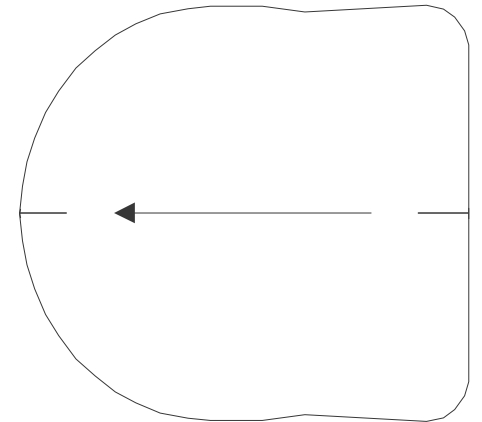

232

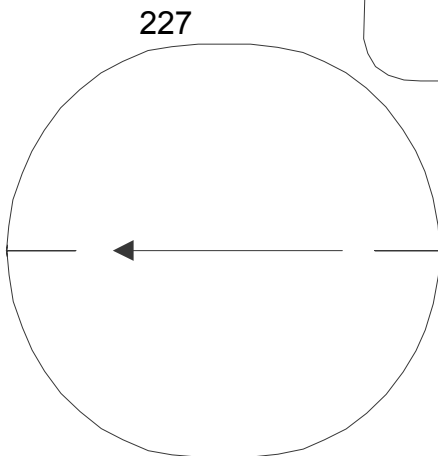

227

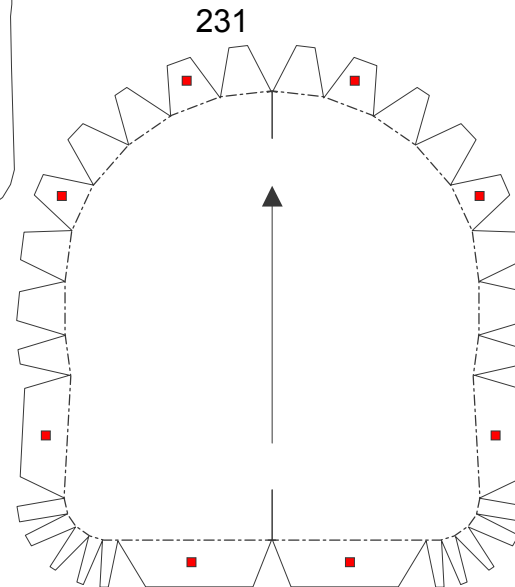

231

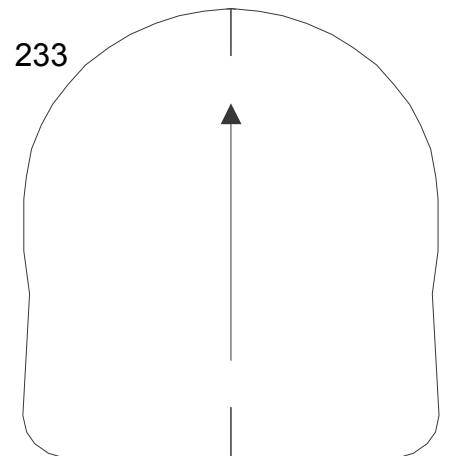

233



STARFLYER

STARFLYER AIRBUS A320 : PATTERN



Canon® is a registered trademark of Canon Inc.
© Canon Inc. © P. Model K. Kiyonaga

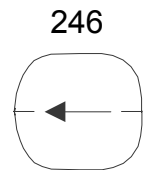
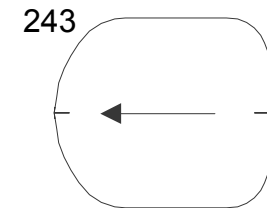
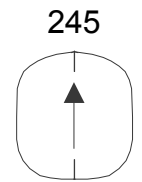
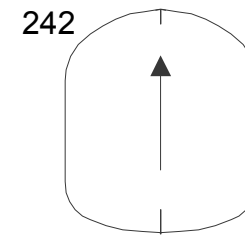
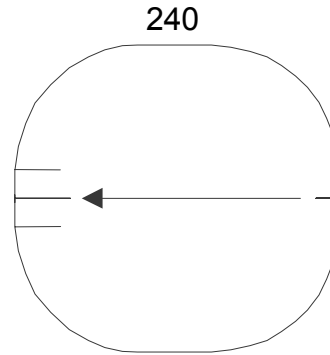
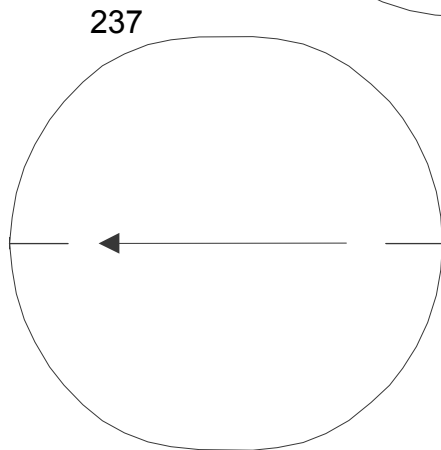
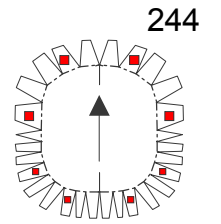
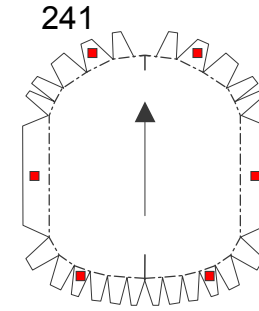
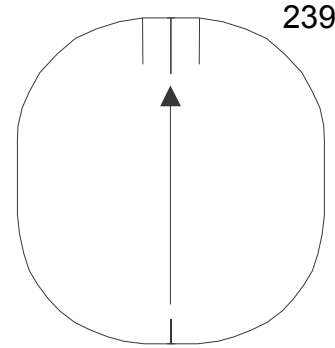
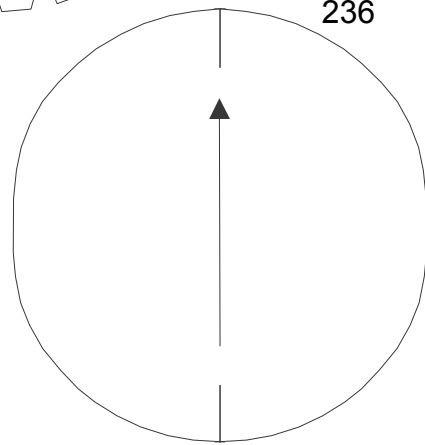
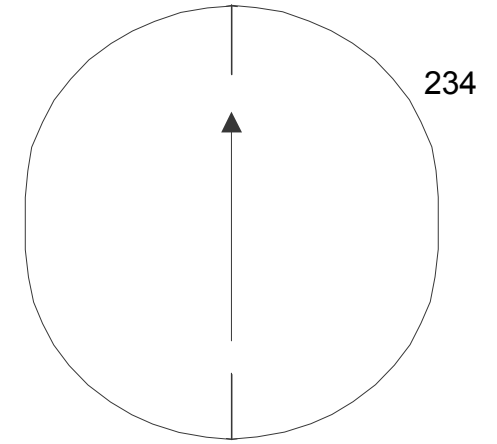
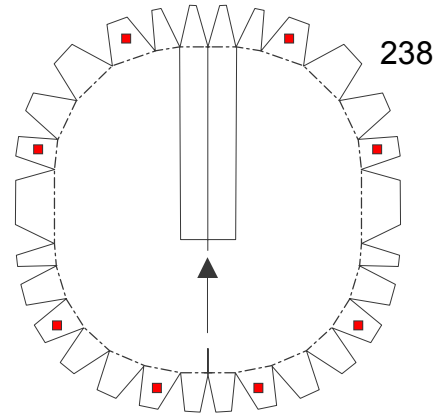
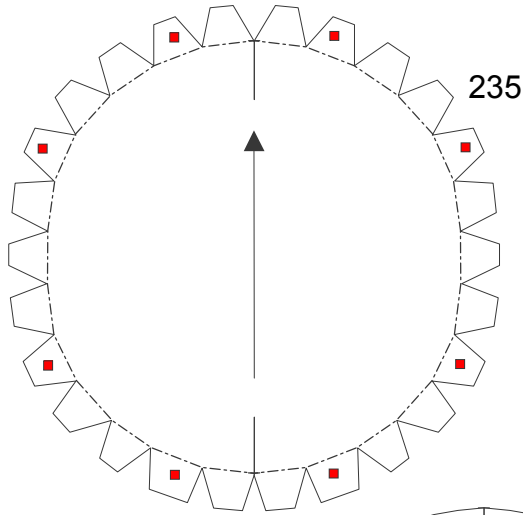



STARFLYER

STARFLYER AIRBUS A320 : PATTERN



Canon® is a registered trademark of Canon Inc.
© Canon Inc. © P. Model K. Kiyonaga

247

248

249

250

251 252 253 254

255

256

257

258

259 260 261 262

263

264

265

266

267 268 269 270

271

272

273

274

275 276 277 278

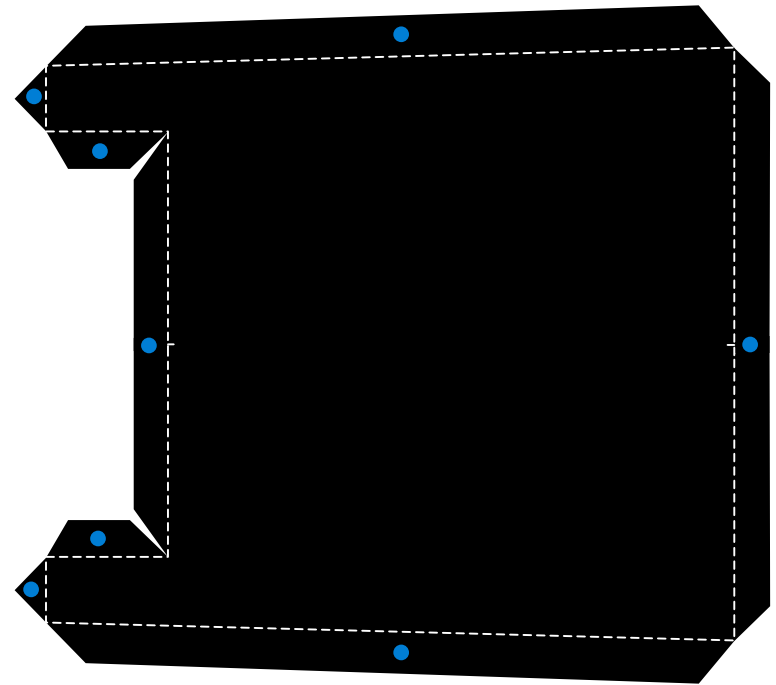
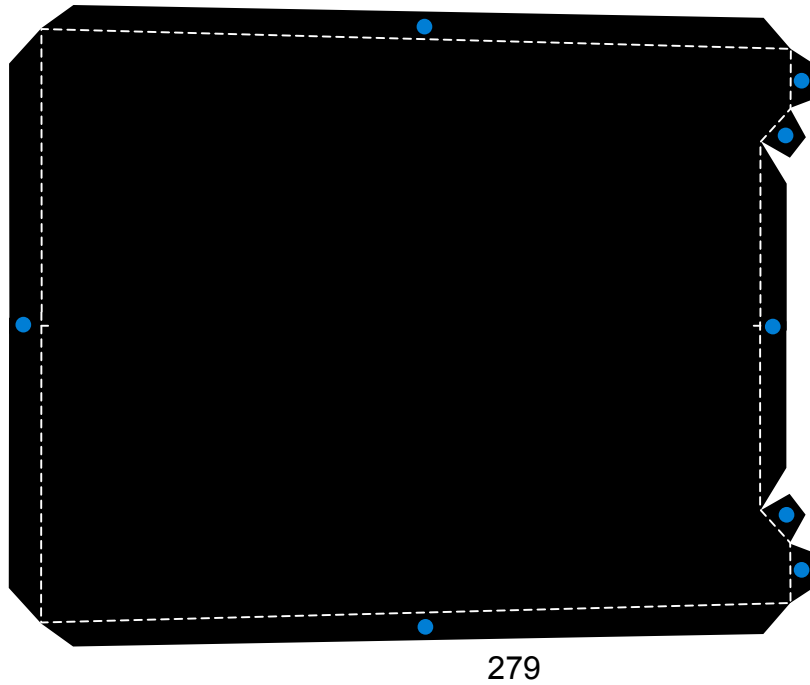



STARFLYER

STARFLYER AIRBUS A320 : PATTERN



Canon® is a registered trademark of Canon Inc.
© Canon Inc. © P.Model K. Kiyonaga

281

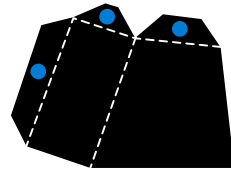

282

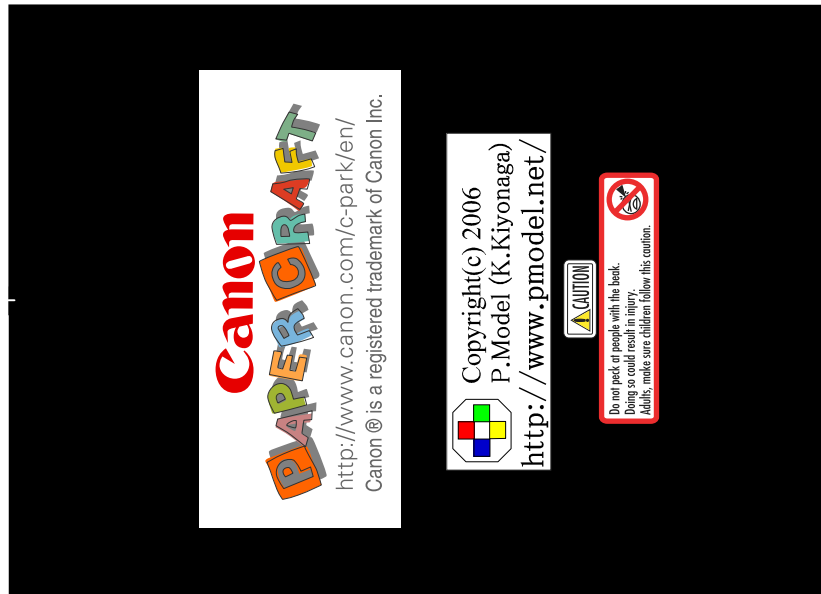
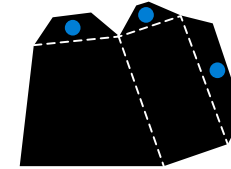

283



284



STARFLYER

STARFLYER AIRBUS A320 : PATTERN

Canon

Canon® is a registered trademark of Canon Inc.
© Canon Inc. © P. Model K. Kiyonaga

